

Xantus

MODULAR, FLEXIBLE, UPGRADEABLE
ROBOTIC SOLUTIONS

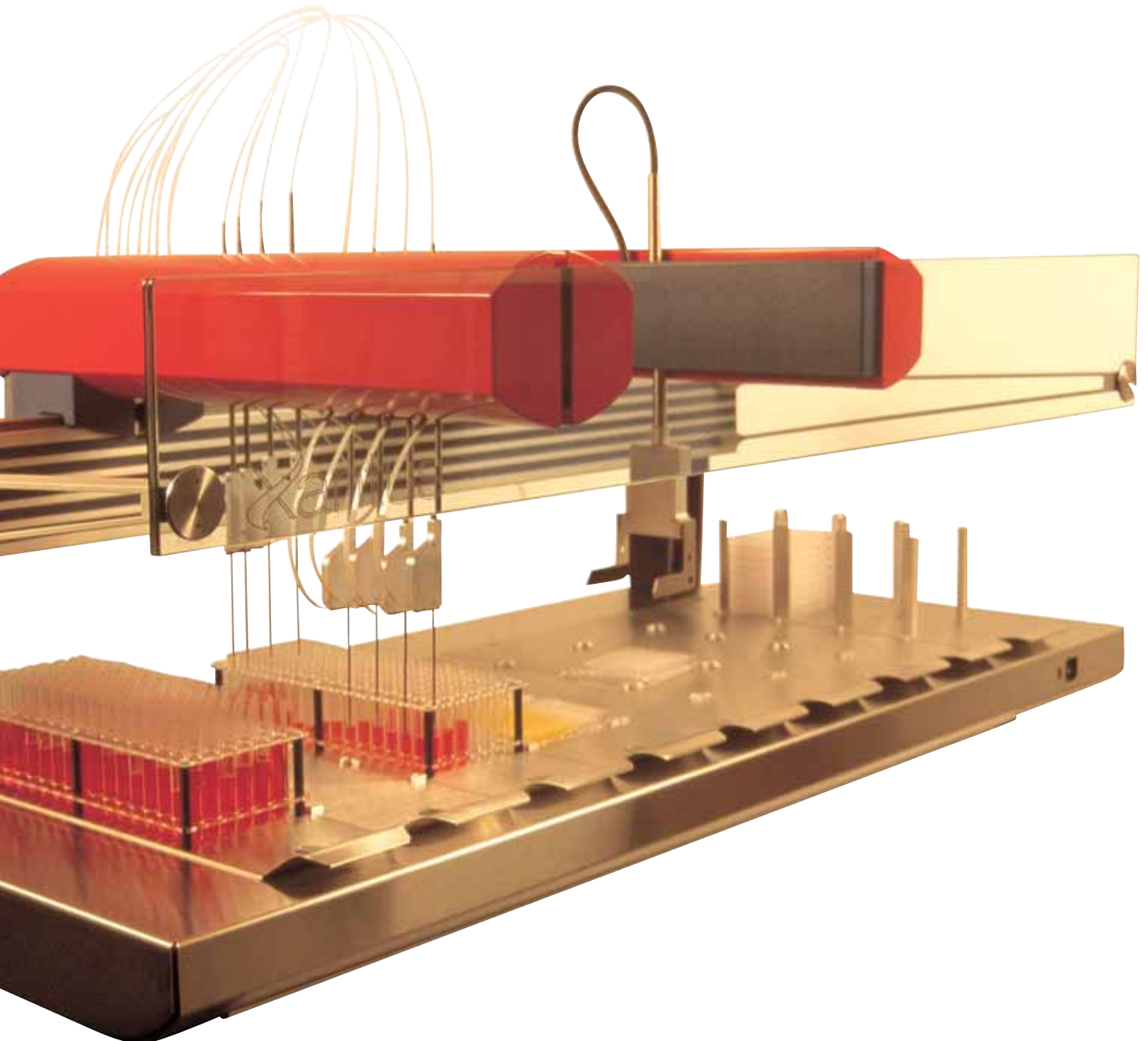

sias

THE ULTIMATE DESIGN

The Sias Xantus is a truly modular state-of-the-art robotic system, combining sophisticated and flexible liquid handling with robotic manipulation. The modular design allows the hardware to be configured to suit a very wide range of applications.

The modular Xantus is a perfect platform for OEM applications, and simplifies both system integration and stand alone robotic automation. The sleek, uncomplicated design integrates robotic and liquid handling functionality into the robotic arm, which glides on an X-rail to access the large flexible deck, and integrated or surrounding modules.

STAND-ALONE WORKSTATION

Your needs for automation may change during the long lifetime of your Xantus robot. The unique modular design means that you can select suitable elements and performance characteristics to make up the ideal workstation, and then upgrade later to increase throughput or to more fully automate a protocol.

OEM

With all functionality housed in the arm, this entire module can be easily integrated into an instrument project. Our CAN bus protocol simplifies integration. Alternatively, the Xantus workstation, including deck, can be customized and optimized as a private label platform to automate any pipetting protocol.

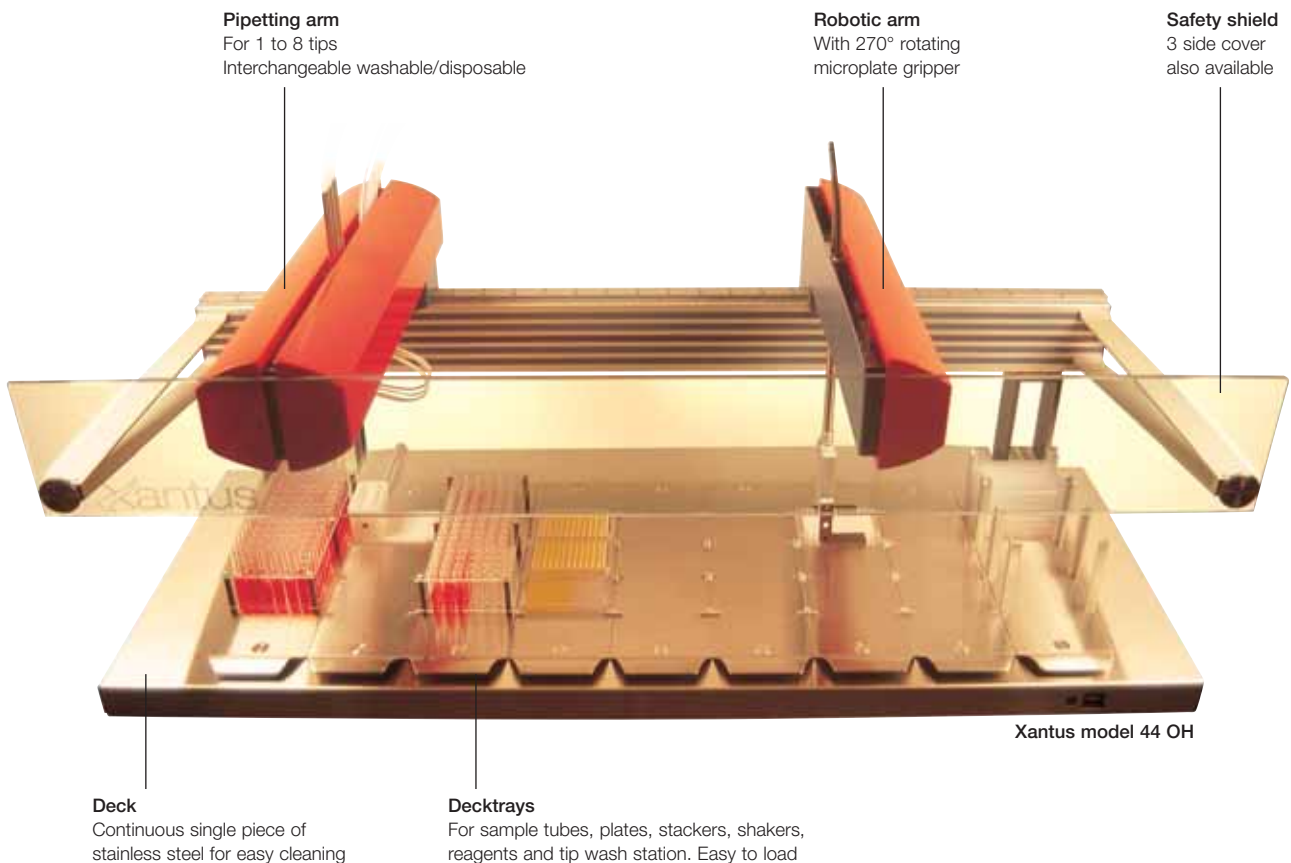

Xantus is composed of a basic frame with one or more robotic arms. Each arm is constructed from one or two arm sections, and each section can carry 1, 2 or 4 pipetting tips, or a robotic handling tool. Several standard configurations are available, and Xantus can be customized for OEM applications.

CUSTOMIZING CONFIGURATIONS

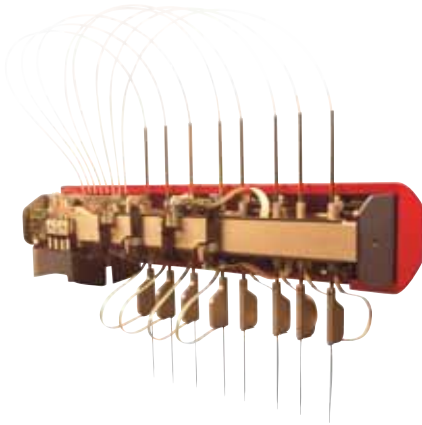

By selecting from a wide range of robotic modules, functional “Plug and Play” modules, options and accessories, you can customize your Xantus to suit the evolving needs of your laboratory. And in most cases you can change the configuration in the future by upgrading.

DESIGN YOUR OWN PIPETTING ARM

- Up to 8 tips per arm
- Flexispan = individual Y and Z movement
- Individual level sensors
- Interchangeable washable and disposable tips.

ROBOTIC HANDLING

- Separate arm, same X-slide
- Software controlled for safety and efficiency
- 270° rotating microplate gripper
 - turn a plate for cross pipetting
 - improved access to other modules on or off the deck
- Increase deck capacity by stacking plates
- Increase efficiency by moving plates between functional modules
 - incubators, coolers, shakers, readers and washers, thermocycler, vacuum assembly, centrifuge etc.

DECK LAYOUT

- 3 standard X-ranges, and 3 standard deck widths (approx. 100 cm, 150 cm and 200 cm)
- Extended X-range option
 - reach modules outside deck
- Decktrays hold samples, plates, stackers, shakers, reagents and the tip wash station
- Simple to use drag and drop software helps you define the labware layout.



Robotic handler

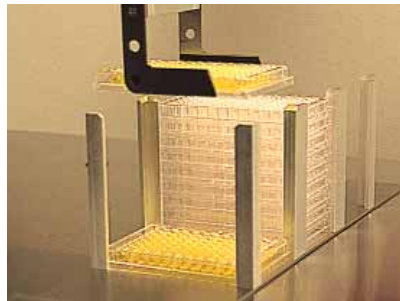

Stacking plates

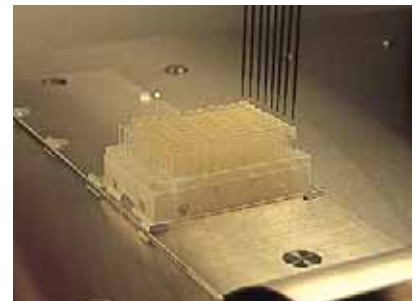

Decktrays

STANDARD XANTUS CONFIGURATIONS

Model	ARM 1		ARM 2	
	Section 1	Section 2	Section 1	Section 2
40 00	4 pipetting tips	–	–	–
40 0H	4 pipetting tips	–	–	robotic handler
44 00	8 pipetting tips		–	–
44 0H	8 pipetting tips		–	robotic handler
44 44	8 pipetting tips		8 pipetting tips	

The above table shows some examples of Xantus configurations. Xantus units are available in various deck widths and with optional X-range extension. Other models may be available.

PRINCIPLES OF LIQUID HANDLING

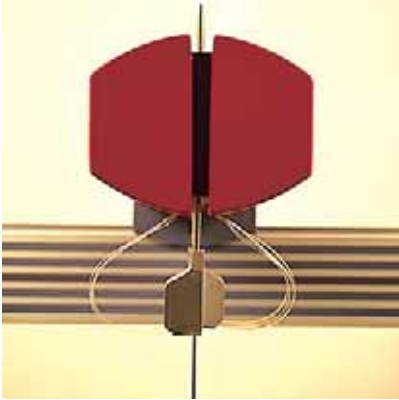

Xantus arm assembly



Micro-pump

The robotic pipetting arm module encloses everything necessary to perform the liquid handling, reducing the need for space consuming external pumps and extended lengths of feed tubing. Xantus uses a principle of positive displacement of liquid in a fluid filled system, where the aliquots of sample and reagent are automatically separated by an airgap. Xantus can pipette using all or only some of the individual channels together, either in single aliquots or by multi-dispensing.

PUMP DESIGN

- Mini toothed wheel pump
- Pipettes 1 μ l to 1 ml, plus continuous system liquid dispensing
- Excellent precision
- No maintenance, no replacement parts.

PIPETTING TIPS

- Up to 8 pipetting tips per arm, up to 2 arms per standard Xantus
- Interchangeable washable and disposable tips
 - select tip format and size for each protocol step
- Flexispan – independent YZ drive and level detector for each tip
 - access consecutive or unevenly spaced tubes and wells (e.g. for cherry picking)
- Each tip can exert a force of 30 N (3 kg)
 - ideal for piercing septa.

Washable tip

- Unique design optimized for precision and minimal carry-over
 - various coatings available
- Total volume of 1 ml
 - sample or reagent contained in the tip
 - no interfaces – optimizes precision.

Disposable tip

- For applications requiring zero carryover
- Various formats and volumes.

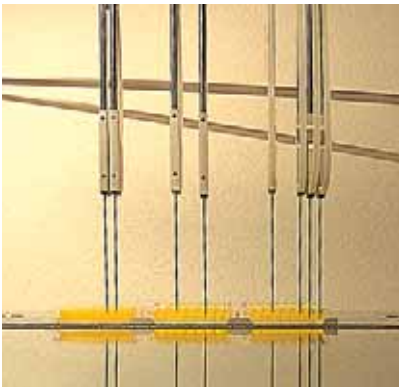

Flexispan



Individual tip level detectors

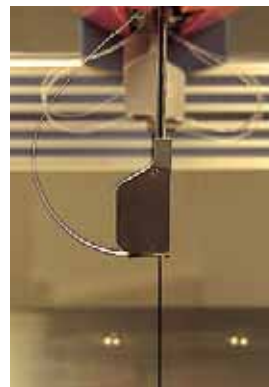

Washable pipetting tip



Disposable tips

ADDING A THIRD DIMENSION

The Xantus deck is large and open on all sides. It provides a canvas on which to place labware and optional modules.

Sample tube racks, microplates and reagents are loaded on the slimline decktrays, which accurately position the labware ready for automation. Most Xantus accessories and options are simply placed on the deck and can be removed when not in use, or rearranged to suit another application protocol.

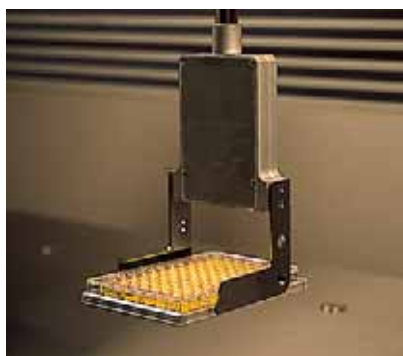
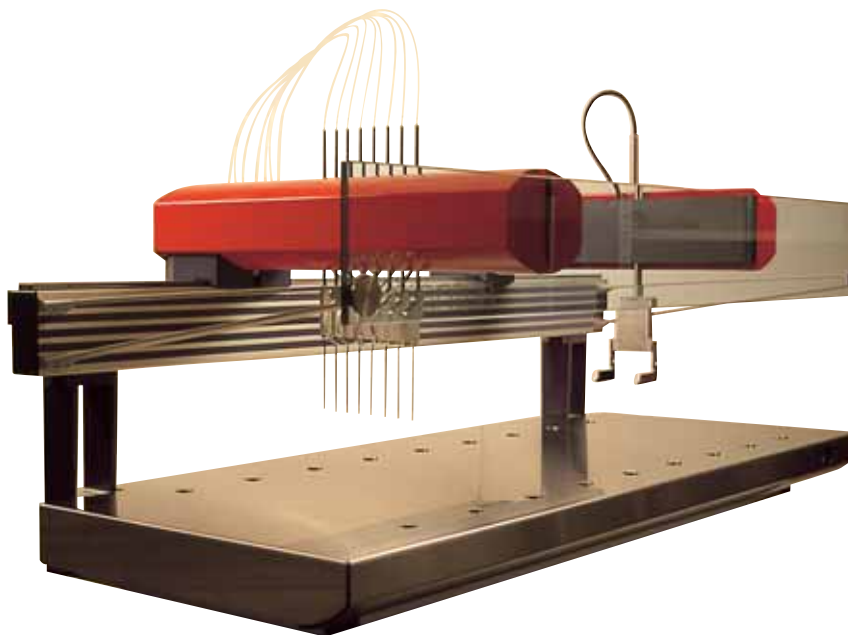

ROBOTIC HANDLING

The separation of the robotic and pipetting arms ensures that robotic function can work independently to increase throughput and efficiency. Plates and other labware are quickly and safely carried between stackers, incubators and other functional modules. Plates can be turned for efficient cross pipetting tasks. When installed on a Xantus with extended X-range, the robotic arm can access modules and accessories situated outside the Xantus deck.

- Creates a useful third dimension to the deck
- Transport plates with or without their lids; remove and replace lids
- Pipette to a plate on the top of a stack
- 270° rotating microplate gripper.

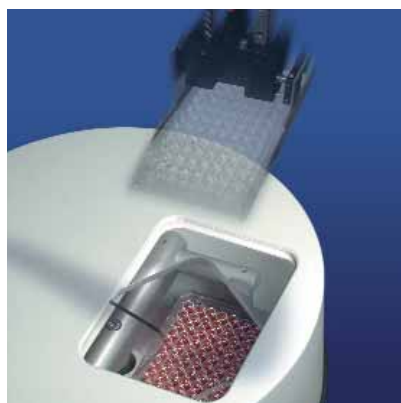
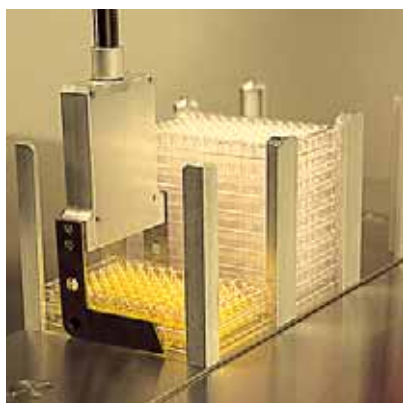

The narrow microplate gripper can access the loading bay of the Ixion centrifuge.

EXPANDING THE RANGE OF AUTOMATION



The basic ID-trax module holds 96 samples and can be expanded in batches of 96.

The functionality of the Xantus can be expanded by using specialized modules and accessories. Most Sias modules are simply placed on the deck and are fully Plug and Play. Third party modules may also be integrated.

SAMPLE TRACKING – ID-TRAX

- Increase security with real-time ID tracking
- Reads barcodes on sample tubes, plates and reagents
- Selective (worklist) pipetting, or batch mode
- Decktop Plug and Play module – can be removed to increase deck capacity when not in use.



Incubator

INCUBATOR

- Holds up to 4 plates, with or without covers
- Plug and Play
- Individual plate drawers
- Minimize drafts and edge effect
- Incubation time and temperature are software controlled.

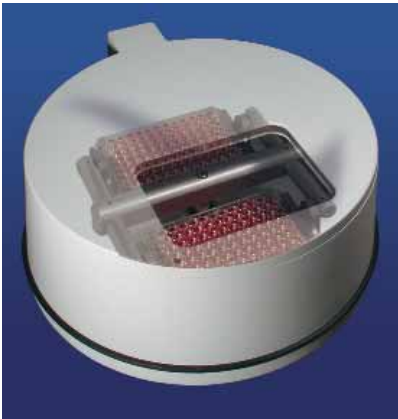

ixion

IXION – INTEGRATED MICROPLATE CENTRIFUGE

Accommodating 2 microplates, deep well plates or gel cards, the Ixion can be integrated into the deck of the Xantus, or can be positioned alongside. Loading, unloading and functions of the Ixion are controlled by the Xantus software.

Features

- rcf up to 2,000 g
- Centrifugation time 5 seconds to 9 hours
- Loading shutter opens and closes under software control
- Automated homing position to permit robotic loading and unloading
- Motion is prevented if the lid is not fully shut
- Automatic sensor detects imbalance, and stops centrifuge if there is excess vibration.

OTHER MODULES

The Xantus design utilizes a CAN protocol to facilitate integration of third party products. The deck is large, and has few limitations for physical integration of hardware. Additionally the Xantus can be delivered with an extended X-range, so that the robotic arms can reach outside the deck to access modules placed alongside.

X-AP – SOFTWARE FOR EVERY APPLICATION

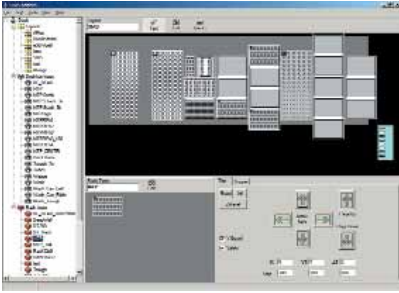

Deckmate allows you to easily define the Xantus deck layout



X-AP stores your pre-optimized methods and displays them in a list for easy selection

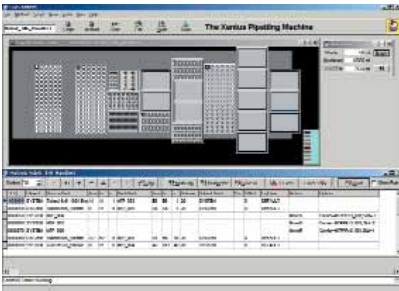

X-AP is powerful and very flexible software designed to set-up and automate all your liquid handling tasks. It can be used to communicate with and/or control functional modules for complete assay automation.

DECKMATE

A drag and drop software used to design the arrangement of samples, reagents, plates, etc. on the deck for each protocol. Deckmate is delivered with an extendable library of labware, so you can focus on designing the best deck for your application.

X-AP

A graphic user interface used to compose and optimize protocols. X-AP has multiple user levels. The programming level allows the definition and optimization of every step. Simply transpose your application step by step into a X-AP method. To automate complex tasks, you can combine several methods into a Script.

- X-AP utilizes a robust database concept which keeps track of all data, and provides a seamless interface with Microsoft® Excel
- X-AP includes a service utilities program, X-Util, designed to simplify system diagnostics. X-Util can also be used to fully customize unique applications, by addressing each module and function individually
- A powerful simulator software is also available – compose and test your methods prior to running them on the Xantus.

Scheduling

- Online scheduling constantly re-evaluates timelines during a run
- Actions shared by different protocols can be consolidated
- Add or remove actions while an application is running
- Time calculation – automatic timing of actions, and correction of estimates
- Graphic display
- Active-X control – can be used for external modules.

Connectivity

- DDE data exchange
- Integrate external module DLLs and “call” from within a run
- Additional functions can be executed via the optional I/O board.
- Import/Export from Excel – methods, labware and pipetting lists can be imported or exported before, during or after a run.

APPLICATION SOFTWARE

X-AP is a very flexible software that can be used to precisely define and optimize your applications. Some pre-optimized application packages are also available (e.g. ELISA, blood grouping, IFA etc.). Please contact us for more details.

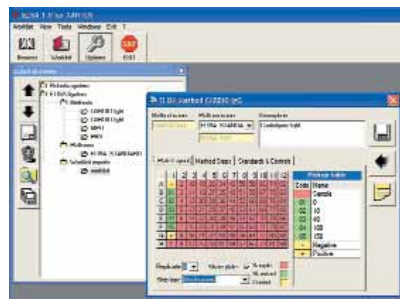

The optional ELISA user interface simplifies the complete automation of plate preparation, processing and data reduction.

SPECIFICATIONS

ACCESSORIES

Microplate shaker	Capacity 1 MTP or deep-well plate; linear, orbital and customized shaking modes
Decktrays	A decktray holds 96 sample tubes; or up to 5 microplates/stacks of 10; DT racks; or reagent racks etc The deck model 200 can accommodate 13 trays The deck model 150 can accommodate 9 trays The deck model 100 can accommodate 5 trays (Tip access to some wells of the 4 & 5 plate trays may be limited)

PIPETTING PERFORMANCE

Carry over	Washable tip: down to 10^{-7} with sufficient tip wash; Disposable tip: Zero
Liquid/clot detector	Capacitance
Precision – gravimetric evaluation	Vol (ul) CV (optimized conditions) 10 2 % > 20 < 1 %
Pumps	Individual mini-toothed wheel pump for each tip
Tip wash	Tip wash station can be placed anywhere on the deck
Speed/throughput	Depends on Xantus configuration – please consult Sias
Tip design	Washable: Optimized for precision and minimal carry-over, various coatings available Disposable: 10 ul, 100 ul, 1000 ul, various formats
Flexispan	Minimum equal spacing between tips 9 mm Maximum equal spacing of tips 55 mm Maximum single spacing 350 mm
Volumes	1 μ l – 1 ml. Volumes outside this range may be possible

ROBOTIC PERFORMANCE

Force in z-direction	30 N
Arm force	240 N at the far end
Handler	Can lift 3 kg
Position Accuracy	+/- 0.2 mm (384 well plates)
z-travel range	150 mm

ID-TRAX (barcode reader)

CCD camera reads most commercially available barcodes, max digits 20
Standard capacity 96 samples, extendable in batches of 96

INCUBATOR TOWER

Capacity 4 microplates. Temperature controllable from 5° C above ambient temperature to 49° C, in steps of 0.1° C, accuracy 0.2° C

OPERATING CONDITIONS

Temperature	15° C to 30° C/60° F to 85° F
Relative humidity	10-85% at 30° C/85° F or below

ELECTRICAL AND COMMUNICATION

	Plug and Play modules simplify the composition of an application system RS232, multiple I/O ports, and a CAN bus facilitate systems integration
Power	Self regulating power supply, 85 to 264 volts AC; 350 watts

SAFETY AND SECURITY

Safety	Operator safety is ensured by the safety guard or an optional cover Xantus is designed for IEC 1010 compliance and bears the CE mark
Security	Sophisticated software combined with real time barcode tracking can eliminate sample tracking errors Software user level definition prevents unauthorized changing of performance data Processes and actions are monitored and logged

ABOUT SIAS

Sias was founded in 2000, based on many years of experience developing and marketing flexible robotic liquid handling and automation. Sias offers expertise in many areas of automation for clinical, blood bank, pharmaceutical and research applications. Our broad understanding of the need for more flexible systems and modules is applied to the development of products for OEM and for the most demanding laboratory applications. Sias is a dedicated and experienced partner who can help you realize your automation projects efficiently and cost effectively.



SIAS AG EICHTAL CH-8634 HOMBRECHTIKON SWITZERLAND
T (+41) 55 254 1122 F (+41) 55 254 1123
E INFO@SIAS.BIZ WWW.SIAS.BIZ